

Instructions



ROTOGEN 1000

**Keep these instructions within
immediate reach**

Translation of the original instructions E - English

 **Collomix**

Version 3.2-20

Contents

1. General information	4
1.1 Symbols used	4
1.2 Information about the operating instructions	4
1.3 Copyright protection	5
2. For your safety	5
2.1 Proper use	5
2.2 Statutory regulations	5
2.3 Assembly	6
2.4 Technical data	6
2.5 Control and display components	7
3. Using for the first time	8
3.1 Unpacking	8
3.2 Setting up	8
3.3 Mains power connection	8
3.4 Trial run	8
3.5 Holding elements	9
4. Operation	10
4.1 Switching the ROTOGEN 1000 on and off	10
4.2 Selecting the homogenization time	11
4.3 Starting the homogenization cycle	11
4.4 Stopping the homogenization cycle prematurely	12
5. Trouble-shooting	13
6. Service and maintenance	14
6.1 Cleaning	14
6.2 Service address	14
6.3 Disposal	14
7. Annex	15
7.1 EC Declaration of Conformity	15
7.2 Warranty	15

1. General information

The ROTOGEN 1000 is a small volume stationary mixer for homogenizing liquid lacquer materials and paints, in particular car repair paints, using mixing cup systems (for example PPS/RPS) for connecting to spray guns.

The sealed container (e.g. mixing toner pots and mixing cups) is placed in a suitable holder/adaptor on the ROTOGEN 1000 and the contents are then homogenized when the container is set in a rotating motion through two axes.

1.1 Symbols used

Important notes and instructions concerned with safety which are used in these operating instructions are indicated by symbols.

It is essential that these notes and instructions relating to work safety are observed and complied with. In all such cases it is important that you take particular care in order to prevent accidents, harm to persons and damage to property.

**DANGER! Risk of injury or death**

This symbol indicates notes and instructions which, if not observed, could impair health or lead to injury, lasting bodily harm or death.

**CAUTION! Risk of damage to property!**

This symbol indicates notes and instructions which, if not observed, could lead to damage, malfunctions and/or the failure of the machine.

**Note!**

This symbol indicates tips and information which you should observe in order to ensure that the machine provides you with efficient and trouble-free service.

1.2 Information about the operating instructions

These operating instructions describe how to use the machine safely and correctly. The notes and instructions on safety, the regulations relating to the prevention of accidents and the general safety regulations applicable to the area of application in the country of use must be observed.

Before starting any work on the machine you must read the operating instructions in full, in particular the section concerned with safety and the applicable safety instructions.

All information, notes and instructions contained in these operating instructions were prepared with due regard to applicable regulations and state-of-the-art technology and on the basis of the knowledge and experience that we have gained over many years.

These operating instructions must be kept in close proximity to the machine where they must be available to all persons working with or on the machine at all times.

COLLOMIX accepts no liability for any errors in this manual or for any accidental or consequential damages arising from or in connection with the supply, performance or use of this material.

The information contained in this manual may be changed at any time without prior notice.

Should these operating instructions contain anything which you do not fully understand or contain instructions, procedures, notes and instructions on safety which do not make perfect sense to you, please contact our sales and service partner:

Collomix GmbH

Daimlerstr. 9, 85080 Gaimersheim
Federal Republic of Germany
Tel.: +49 (0)8458 32 98 - 0
Fax.: +49 (0)8458 32 98 30
www.collomix.com

1.3 Copyright protection

All information, texts, drawings, illustrations and other forms of representation are protected under copyright law and may not be reproduced or stored, processed or duplicated in an electronic system without the written permission of Collomix GmbH.

2. For your safety

The ROTOGEN 1000 has been developed, manufactured and tested in accordance with fundamental safety requirements.

Nevertheless, it may be a source of danger if misused or used for any purpose other than that for which it is intended by persons who are not suitably qualified and trained.

2.1 Proper use

Provided users pay due regard to general constraints, the ROTOGEN 1000 is suitable for homogenizing the following:

- **Liquid materials, especially paints and lacquers.**
- **Suitable additives (including hardeners, thinners, etc.).**

The ROTOGEN 1000 must not be operated in any way other than described in this manual. In particular, the following are not permitted:

- Operation in any areas where there is a potentially explosive atmosphere.
- Operation with defective or missing parts.
- To bridge, deactivate or remove any safety devices.
- The use of non-original replacement parts.
- Running the machine for too long, which can potentially lead to damage to the mixing container.
- The use of unsuitable mixing containers and/or unsuitable holding elements.

Observe not only the information provided by the lacquer manufacturer about the mixing formulas and about the processing of the lacquers and paints but also the safety data sheets!



2.2 Statutory regulations

The statutory regulations, requirements and standards to be complied with revolve mainly around the following:

- The physical environment at the premises
- The materials to be processed
- Other potentially hazardous influences (for example, dust exposure, etc.)



2.3 Assembly



Machine components

1. Control panel	2. Holding element
3. Guard	4. Housing

2.4 Technical data

Mains connection EU version:	230 V AC / 50-60 Hz
Mains connection US version:	120 V AC / 50-60 Hz
Power rating:	60 VA
Speed:	320 rpm
Mixing capacity:	50 ml – 1000 ml (max. container weight 2.0 kg)
Noise level:	< 70dB (A)
Machine weight:	Approx. 14.5 kg
Dimensions :	W = 270 x D = 320 x H = 310 mm
Ambient temperature:	+5°C - +40°C

2.5 Control and display components

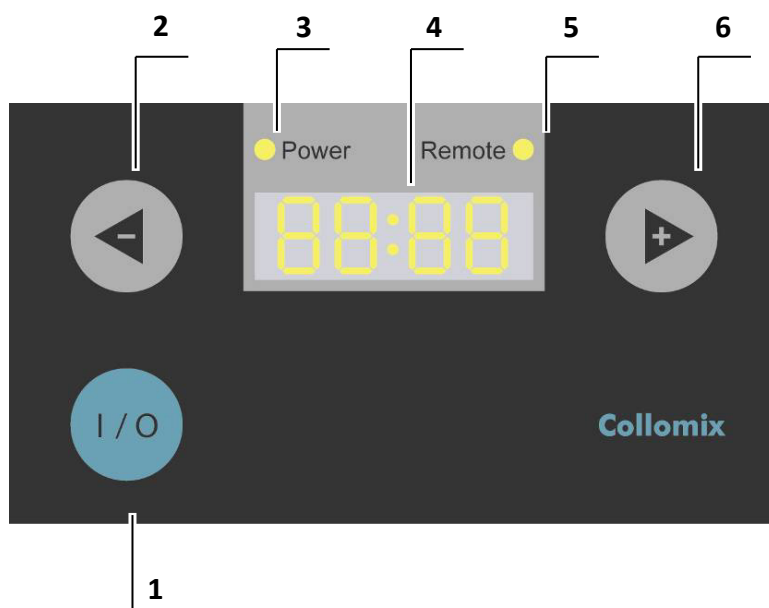

1	I/O button	<ul style="list-style-type: none"> • Switches on the ROTOGEN 1000. • Starts the homogenization process. • Stops the homogenization process. • Switches off the ROTOGEN 1000 when pressed for longer.
2	- button	<ul style="list-style-type: none"> • For selecting the homogenizing time.
3	Power	<ul style="list-style-type: none"> • Illuminated when the ROTOGEN 1000 is connected to the mains power supply.
4	Display	<ul style="list-style-type: none"> • Displays the selected homogenizing time when at rest. • Displays the remaining homogenizing time while homogenization is in progress. • Displays operational messages and error messages.
5	Remote	<ul style="list-style-type: none"> • Illuminated when the ROTOGEN 1000 is in remote control mode.
6	+ button	<ul style="list-style-type: none"> • For selecting the homogenizing time.

3. Using for the first time

3.1 Unpacking

Please check the ROTOGEN 1000 immediately after unpacking for any visible signs of external damage. Should you discover any damage, please advise the forwarding agent and contact your dealer without delay.

We would also recommend that you record any damage with a digital camera.



Keep the packaging material just in case you need it for further delivery purposes in future, for example if any repairs are needed.

3.2 Setting up

Set the ROTOGEN 1000 up on a firm, horizontal and vibration-free surface. If required, the machine can also be set up on a wall bracket which is available as an option.

Ensure that the operating temperature range is between +5°C and +40°C (ideally 20°C) and ensure that the machine is not exposed to direct sunlight or excessive temperature fluctuations which might cause it to heat up beyond permissible levels.

3.3 Mains power connection

Connect the mains power cable from the ROTOGEN 1000 to a socket outlet with earthing contact which has a 10A fuse.

Place the mains cable in a way to prevent from stumbling or snagging.

3.4 Trial run















To check that the machine is in good working order, you must carry out a trial run **with a mixing container** when you are starting up the ROTOGEN 1000 for the first time or after carrying out maintenance work or repairs.

3.5 Holding elements

The ROTOGEN 1000 is equipped with interchangeable holding elements and adapters for enabling toner pots, mixing cups and other containers from different manufacturers to be used for mixing. The mixer comes with the blue holding element # 72225 intended for paint cans with a diameter \varnothing 110mm \pm 1,5mm. Mixing containers with other diameters always requires the use of a suitable adapter.

Make sure that you always use the right element/adapter for the respective mixing cup system. The use of an unsuitable holding element may lead to damage to the machine and/or incomplete homogenization!



Holding element and adapter for 3M™ PPS			
<ul style="list-style-type: none"> • PPS – 700 ml • PPS – 900 ml 		+	
	# 72225		# 62997
<ul style="list-style-type: none"> • PPS – 200 ml 		+	
	# 72225		# 72231
Holding element and adapter for SATA® RPS			
<ul style="list-style-type: none"> • RPS – 900 ml • RPS – 600 ml 		+	
	# 72225		# 62996
<ul style="list-style-type: none"> • RPS – Sata Mini 300 ml 		+	
	# 72225		# 72238
Holding element for mixing toner pots (Glasurit, DuPont, Spies Hecker, Standox, among others)			
<ul style="list-style-type: none"> • Toner pot, 0.5 l, metal/plastic, diameter 110mm \pm1.5mm • Toner pot, 1.0 l, metal/plastic, diameter 110mm \pm1.5mm 			
	# 72225		# 62997
<ul style="list-style-type: none"> • Plastic bottle, 0.125 ml (Glasurit/R-M) 		+	
	# 72225		# 72229
<ul style="list-style-type: none"> • Laboratory cup, 300 ml 		+	
	# 72225		# 72230



Pull out the holding element you wish to replace from the quick-change mount. Insert the new holding element in the quick-change mount, turn it until you feel it latch in and then press until it is fully locked in place.

4. Operation

Check that all safety-relevant parts of the ROTOGEN 1000 are in good working order before beginning with your work. Arrange for authorized service partners to replace defective or damaged parts before you work with the machine again.

Do not reach into the rotating parts of the machine while mixing.



4.1 Switching the ROTOGEN 1000 on and off

Once the ROTOGEN 1000 has been connected to the mains power supply, the software version number appears for a moment on the display. The compact mixer then shows a message to indicate that it is ready for operation, with the homogenization time which was used last.

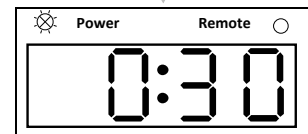
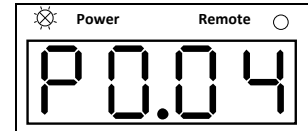

Initialization

To **switch off** the ROTOGEN 1000, press the I/O button and keep it pressed until the display goes off and only the power LED shows that the machine is still on standby.

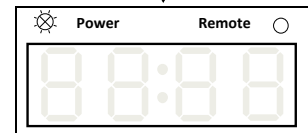
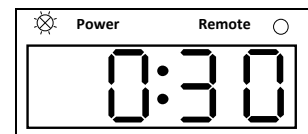

Switching off

To **switch on** the ROTOGEN 1000, press the I/O button momentarily; the machine then shows a message to indicate that it is ready for operation, with the homogenization time which was used last.

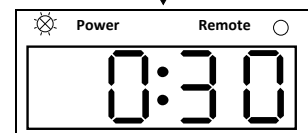
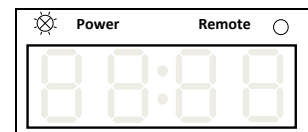

Switching on

4.2 Selecting the homogenization time

Press the **+** button or **-** button to select the homogenization time in 10 second increments.

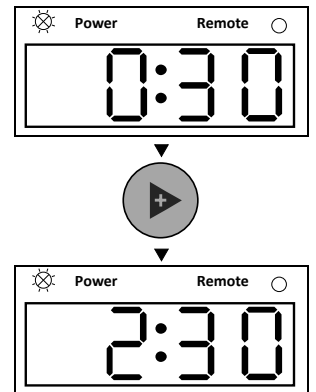

Changing the homogenization cycle time

4.3 Starting the homogenization cycle

To start the homogenization cycle, press the **I/O** button momentarily. The display shows the remaining homogenizing time while homogenization is in progress.

When the homogenization time comes to an end, the display shows **rdy** and the mixing speed reduces until the compact mixer comes to a complete stop.

The next mixing cycle can then be started with the homogenization time which was used last.

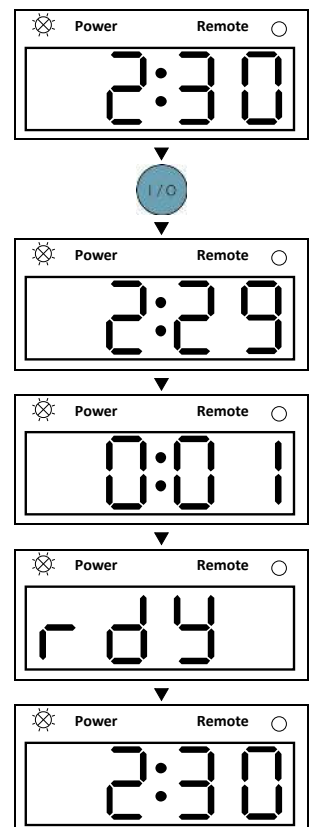

Homogenization cycle

4.4 Stopping the homogenization cycle prematurely

The homogenization cycle can be stopped prematurely at any time by pressing the **I/O button** momentarily.

This quickly slows down the homogenization cycle and brings it to a stop. Until the compact mixer has come to a complete stop, the display shows **Stop**.

The next mixing cycle can then be started with the homogenization time which was used last.

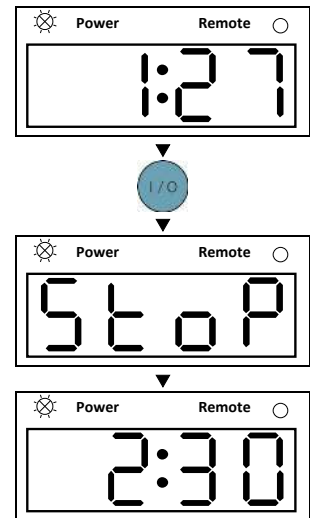

Stopping the homogenization time prematurely

5. Trouble-shooting

Using the trouble-shooting tables listed in this chapter, you can check whether you are able to correct the errors yourself or whether you need to call the customer service department.

Display read-out	Status of the machine	Check the following
	<p>The machine stops during the homogenization cycle and the display shows tErr.</p>	<p>The machine was overloaded. Give the lacquer mixer several minutes to cool down.</p> <p>Check whether the maximum permissible load of 2.0 kg was exceeded.</p> <p>Check whether the right holding element for the mixing container was used.</p> <p>Check whether the holding element is fully locked in place in the mount.</p> <p>Check whether the compact mixer is exposed to additional heat from sunlight or any sources of heat, which cause it to switch off because the temperature of the machine gets too high.</p>
	<p>The homogenization time on the display is running but the container fails to be mixed.</p>	<p>The mixing motor has been forced out of cycle because of imbalance or overloading.</p> <p>Check whether the maximum permissible load of 2.0 kg was exceeded.</p> <p>Check whether the right holding element for the mixing container was used.</p> <p>Check whether the holding element is fully locked in place in the mount.</p> <p>The spring clips in the holding element are defective.</p>



Before calling the customer service department, please make a note of the serial number of the ROTOGEN 1000 and the error code being shown in the display.

6. Service and maintenance

The machine does not contain any components requiring regular servicing.

6.1 Cleaning

Remove all residual traces of lacquer immediately. Clean the foil on the front of the control panel with a damp cloth.

To make it easier to clean the compact mixer, the guard (2) can be removed. To do so, pull off the holding element (1) and undo the three fastening screws (3).

Reassemble by following these procedures in reverse order, taking care to ensure that the holding adapter moves freely!

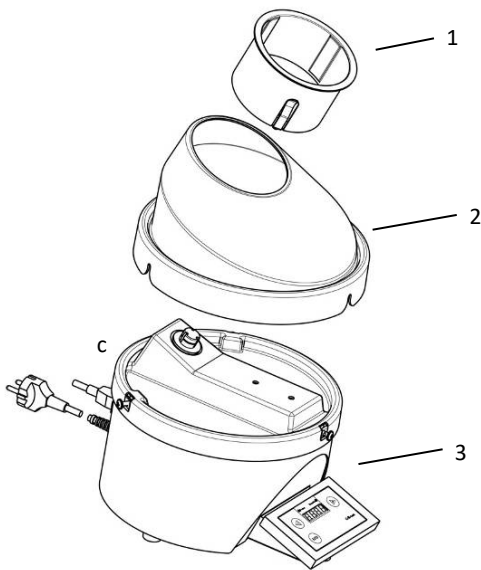

Always disconnect the ROTOGEN 1000 from the mains power supply before starting any cleaning work.

Always fit the guard back in place immediately after completion of any such work. Never use the machine without the guard attached.



6.2 Service address

In the event of any faults or defects, please contact our sales and service partner:

Collomix GmbH
Daimlerstr. 9, 85080 Gaimersheim
Federal Republic of Germany
Tel.: +49 (0)8458 32 98 - 0
Fax.: +49 (0)8458 32 98 30

Servicing work may only be carried out by the manufacturer or an authorized sales and service partner.



6.3 Disposal

The device, accessories and packaging must be recycled in an environmentally friendly manner.

According to EU Directive 2002/96/EC on waste electrical and electronic equipment (WEEE) and its implementation in national legislation, electrical equipment that is no longer in use must be collected separately and recycled in an environmentally friendly manner. **Do not dispose electrical equipment with household waste!**

If you have any questions about disposal, please contact the manufacturer directly.



7. Annex

7.1 EC Declaration of Conformity

We declare herewith that this product, the ROTOGEN 1000, conforms with the following standards and standard-setting documents:

EN 60204-1:2018, EN ISO 12100:2010, EN ISO 13849-1:2015, EN IEC 63000:2018
EN 61000-3-3:2013 + A1:2019, EN 61000-6-3:2007 + A1:2011, EN IEC 61000-3-2:2019,
EN IEC 61000-6-2:2019

in accordance with directives: 2006/42/EG, 2014/30/EU, 2011/65/EU

Technical documentation can be requested from: Collomix GmbH, Abt. Technische Entwicklung,
Daimlerstr. 9, 85080 Gaimersheim, Germany

Gaimersheim, 02/12/2022



Alexander Essing
Managing Director

Manufacturer:
Collomix GmbH
Daimlerstr. 9, 85080 Gaimersheim
Federal Republic of Germany
Tel.: +49 (0)8458 32 98 - 0
Fax: +49 (0)8458 32 98 30



This declaration of conformity will lose its validity if any changes or modifications are made to the ROTOGEN 1000 without the manufacturer's approval.



7.2 Warranty

For your rights in the event any rectifications become necessary, please read our General Delivery Terms and Conditions.

You find these on our website www.collomix.de. We are happy to send you our General Delivery Terms and Conditions on request.

Collomix GmbH
Daimlerstr. 9, 85080 Gaimersheim
Federal Republic of Germany
Tel.: +49 (0)8458 32 98 - 0
Fax.: +49 (0)8458 32 98 30
www.collomix.com
